

27-5.2-CL15

Wall Mounted Exposed Bath Set with Hand Shower

Hand Shower Flow Rate: 1.75 GPM

Note: Some building codes require remote pressure balance valves for anti-scald

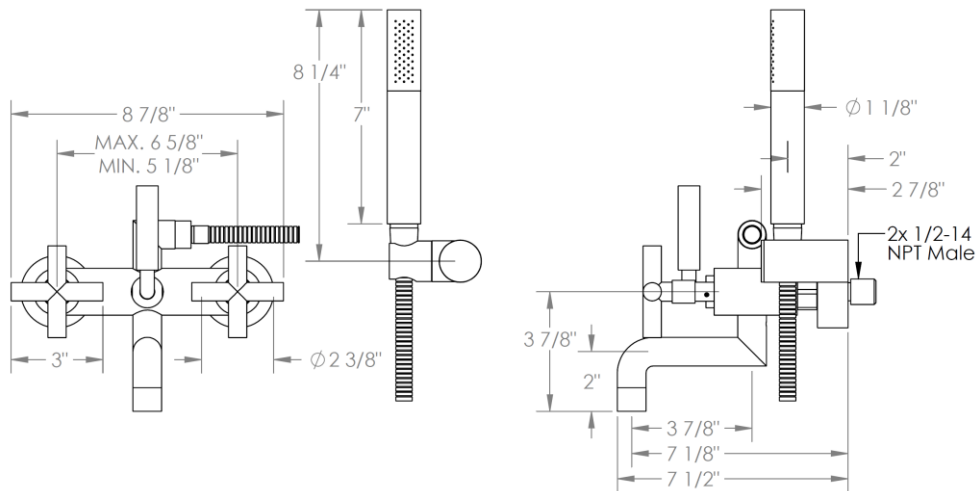

Meets the applicable requirements of ASME A112.18.1-2005/CSA B125.1-05, entitled "Plumbing Supply Fittings"

WATERMARK DESIGNS 1/31/2019

350 Dewitt Ave Brooklyn NY 11207 USA T 718 257 2800 F 718 257 2144 info@watermark-designs.com