

OSLO COLLECTION

GLASS MOUNTED TOWEL

BAR 18"/24"/30"

144180TG

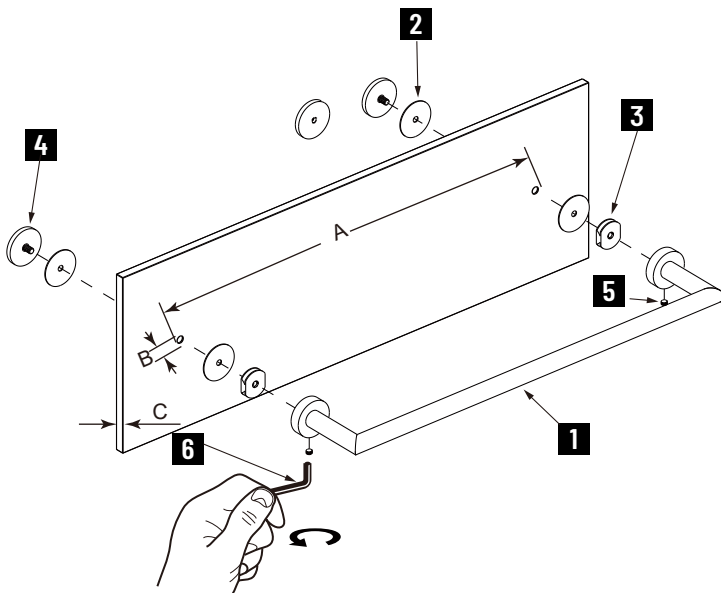

- 1. Towel Bar x 1
- 2. Clear Gasket x 4
- 3. Fixing Bracket x 2
- 4. End Cap x 2
- 5. Set Screw M5 x 2
- 6. Allen Key 2.5mm x 1

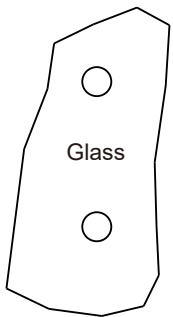

GLASS INFO

	Glass Hole C-C Distance	
A	18"/460mm	18" Towel Bar
B	1/2"(12mm)	Glass Hole Diameter
C	6-12mm	Glass Thickness

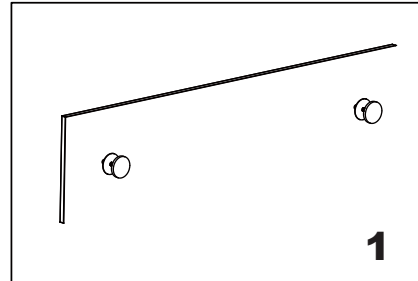

Install the end cap (bolts) through the glass holes, make sure the rubber gaskets are between end caps & glass.

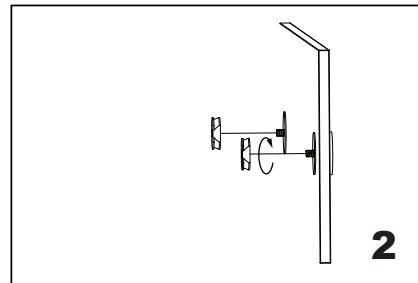

Screw in the fixing brackets into the end cap bolts.

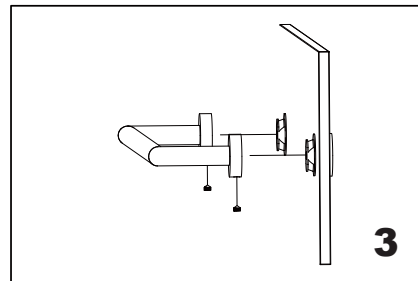

Add the towel bar on the fixing brackets, make sure the set screws holes in the bottom.

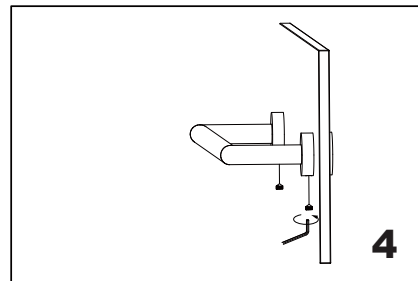

Fix the set screws on the end caps, tighten it to avoid loose from fixing brackets.